

FDC6901L Integrated Load Switch

Features

- Three Programmable Slew Rates
- Reduces Inrush Current
- Minimizes EMI
- Normal Turn-Off Speed
- Low-Power CMOS Operates Over Wide Voltage Range
- High Performance Trench Technology for Extremely low $R_{DS(ON)}$
- RoHS Compliant

General Description

This device is particularly suited for compact power management. In portable electronic equipment where 2.5V to 6V input capability is needed. This load switch integrates a Slew Rate Control Driver that drives a P-Channel Power MOSFET in one tiny SuperSOT™-6 package. The integrated slew rate control driver is specifically designed to control the turn on of the P-Channel MOSFET in order to limit the inrush current in battery switching applications with high capacitance loads. For turn-off, the IC pulls the MOSFET gate up quickly.

Applications

- Load switch
- Power management

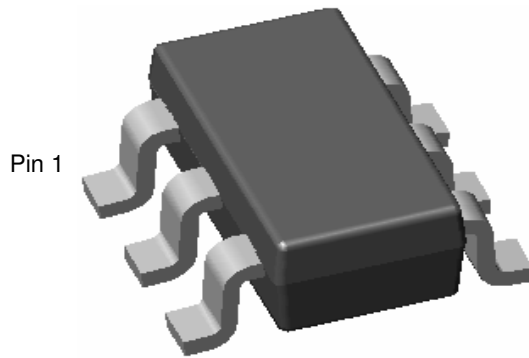

SuperSOT™-6

Package Marking and Ordering Information

Device Marking	Device	Reel Size	Tape Width	Quantity
.901	FDC6901L	7"	8mm	3000 units

Pin Configuration

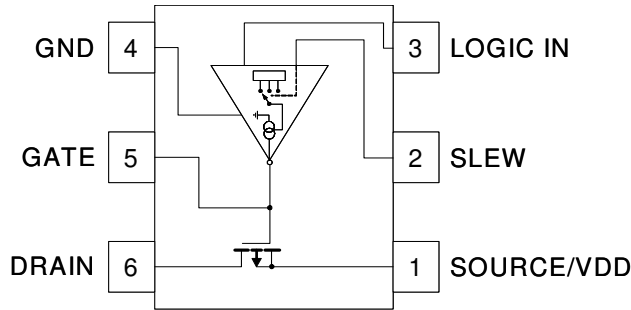

Absolute Maximum Ratings

Parameter	Min.	Max.	Unit
Supply Voltage	-0.5	10	V
DC Input Voltage (Logic Inputs)	-0.7	9	V
Power Dissipation			
Storage Junction Temperature	-55	150	°C
Thermal Resistance, Junction to Ambient		180	°C/W
Thermal Resistance, Junction to Case		60	°C/W

Recommended Operating Range

Parameter	Min.	Max.	Unit
Supply Voltage	2.7	6	V
Operating Junction Temperature	-55	150	°C

Electrical Characteristics

$T_A = 25^\circ\text{C}$ unless otherwise noted

Parameter	Symbol	Conditions	Min.	Typ.	Max.	Units
Logic Levels						
Logic High Input Voltage	V_{IH}	$V_{DD} = 2.7\text{V to } 6.0\text{V}$	70% V_{DD}			V
Logic Low Input Voltage	V_{IL}	$V_{DD} = 2.7\text{V to } 6.0\text{V}$			25% V_{DD}	V
Off Characteristics - Slew Rate Control Driver						
Supply Input Breakdown Voltage	BV_{DG}	$I_{DG} = 10\mu\text{A}, V_{IN} = 0\text{V}, V_{SLEW} = 0\text{V}$	9			V
Slew Input Breakdown Voltage	BV_{SLEW}	$I_{SLEW} = 10\mu\text{A}, V_{IN} = 0\text{V}$	9			V
Logic Input Breakdown Voltage	BV_{IN}	$I_{IN} = 10\mu\text{A}, V_{SLEW} = 0\text{V}$	9			V
Supply Input Leakage Current	IR_{DG}	$V_{DG} = 8\text{V}, V_{IN} = 0\text{V}, V_{SLEW} = 0\text{V}$			100	nA
Slew Input Leakage Current	IR_{SLEW}	$V_{SLEW} = 8\text{V}, V_{IN} = 0\text{V}$			100	nA
Logic Input Leakage Current	IR_{IN}	$V_{IN} = 8\text{V}, V_{SLEW} = 0\text{V}$			100	nA
Off Characteristics - Slew Rate Control Driver + P-Channel MOSFET						
MOSFET Breakdown Voltage	BV_{DSS}	$I_D = -250\mu\text{A}$	9			V
MOSFET Leakage Current	I_{DSS}	$V_R = 16\text{V}$			100	nA
On Characteristics - Slew Rate Control Driver						
Output/Gate Current	I_G	$I_D = -250\mu\text{A}$	Slew Pin = Open	90		μA
			Slew Pin = GND	1		μA
			Slew Pin = V_{DD}	10		nA

Electrical Characteristics Cont.

$T_A = 25^\circ\text{C}$ unless otherwise noted

Parameter	Symbol	Conditions	Min.	Typ.	Max.	Units
On Characteristics - P-Channel MOSFET						
Gate Threshold Voltage	$V_{GS(th)}$	$V_{DS} = V_{GS}, I_D = -250\mu\text{A}$	-0.6	-1	-1.5	V
Static Drain-Source On Resistance	$R_{DS(ON)}$	$V_{GS} = -4.5\text{V}, I_D = -1.5\text{A}$		120	145	$\text{m}\Omega$
		$V_{GS} = -2.5\text{V}, I_D = -1.2\text{A}$		170	210	$\text{m}\Omega$
On Characteristics - Slew Rate Control Driver + P-Channel MOSFET						
Dropout Voltage	V_{DROP}	$V_{DD} = 6\text{V}, V_{IN} = 2.5\text{V to } 6\text{V}, I_L = 1.5\text{A}$		160	300	mV
		$V_{DD} = 6\text{V}, V_{IN} = 2.5\text{V to } 6\text{V}, I_L = 1.2\text{A}$		130	300	mV
Load Switch On Resistance	R_{ON}	$V_{DD} = 6\text{V}, V_{IN} = 2.5\text{V to } 6\text{V}, I_L = 1.5\text{A}$		105	180	$\text{m}\Omega$
		$V_{DD} = 6\text{V}, V_{IN} = 2.5\text{V to } 6\text{V}, I_L = 1.2\text{A}$		110	210	$\text{m}\Omega$
Load Current	I_{LOAD}	$V_{GS} = 2.5\text{V}, V_{DS} = 6\text{V}$	3			A
P-Channel Switching Times ($V_{SUPPLY} = 5.5\text{V}, V_{DD} = 5.5\text{V}, \text{Logic IN} = 5.5\text{V}, I_{LOAD} = 1.5\text{A}$)						
Delay On Time	t_{dON}	Slew Pin	= Open		6.2	μs
			= GND		42	μs
			= V_{DD}		115	μs
V_{OUT} Rise Time	t_R	Slew Pin	= Open		6.75	μs
			= GND		124	μs
			= V_{DD}		162	μs
Output Slew Rate	dv/dt	Slew Pin	= Open		600	V/ms
			= GND		41	V/ms
			= V_{DD}		24	V/ms

Typical Characteristics

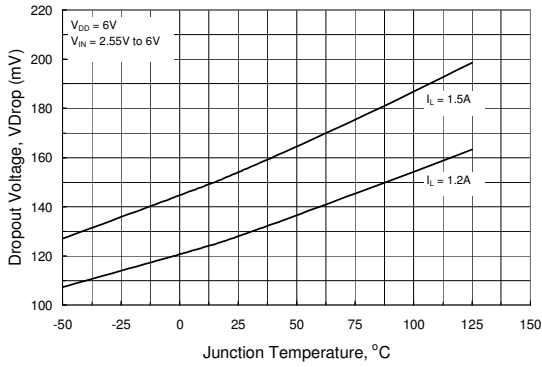

Figure 1. Dropout Voltage vs. Temperature (SLEW = OPEN)

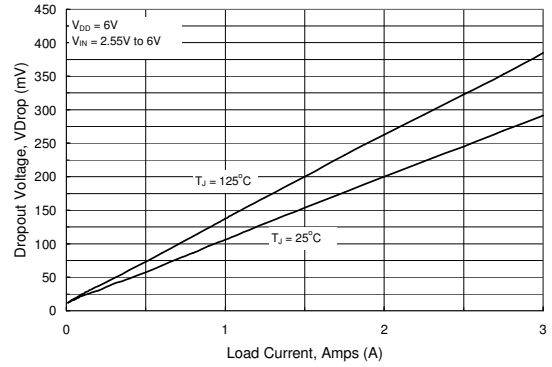

Figure 2. Dropout Voltage vs. Load Current (SLEW = OPEN)

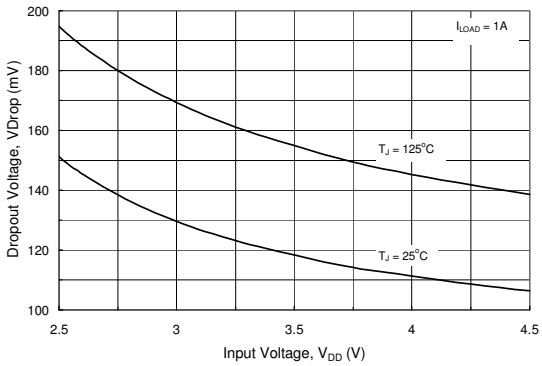

Figure 3. Dropout Voltage vs. Input Voltage (SLEW = OPEN)

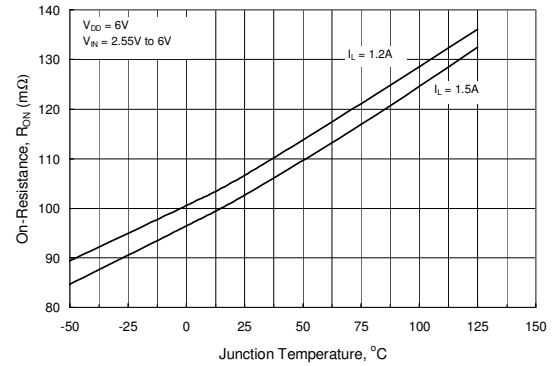

Figure 4. On Resistance vs. Temperature (SLEW = OPEN)

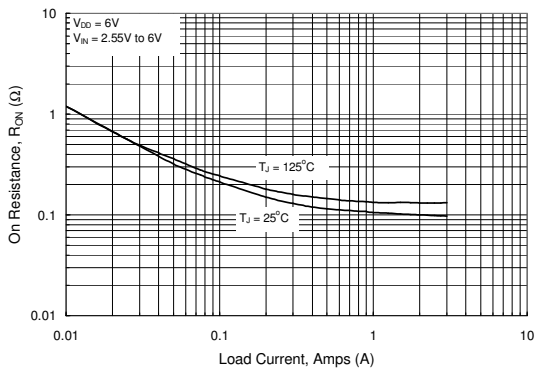

Figure 5. On Resistance vs. Load Current (SLEW = OPEN)

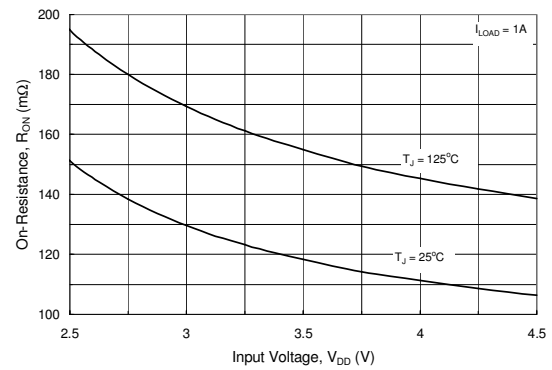

Figure 6. On Resistance vs. Input Voltage (SLEW = OPEN)

Typical Characteristics

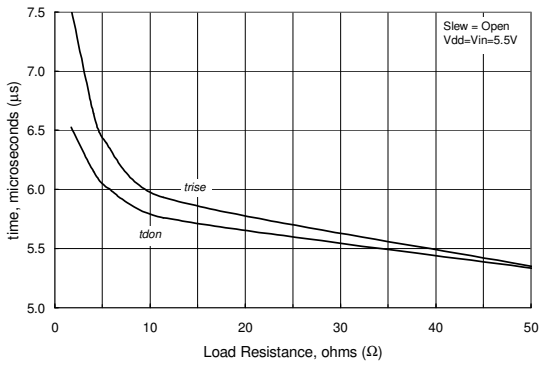

Figure 7. Switching Time vs. Load Resistance (SLEW = OPEN)

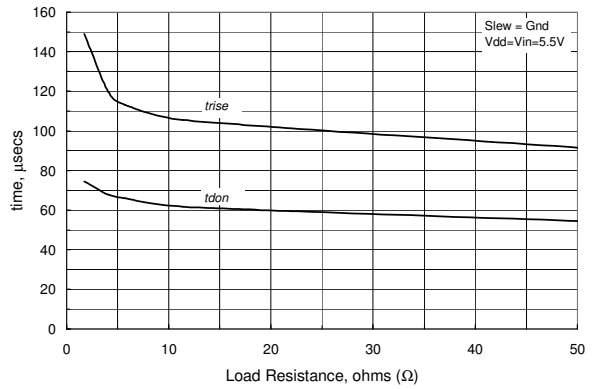

Figure 8. Switching Time vs. Load Resistance (SLEW = GROUND)

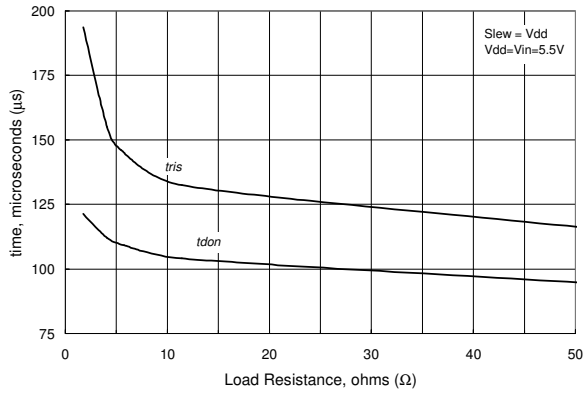

Figure 9. Switching Time vs. Load Resistance (SLEW = V_{DD})

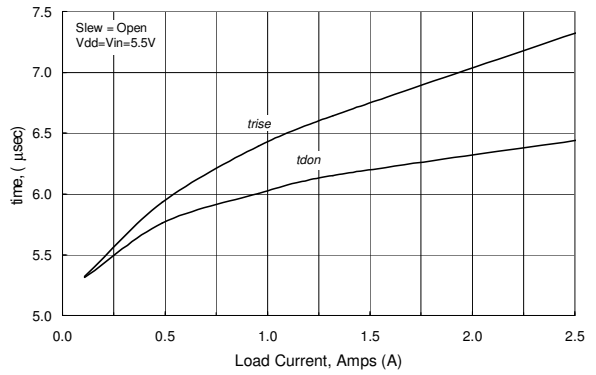

Figure 10. Switching Time vs. Load Current (SLEW = OPEN)

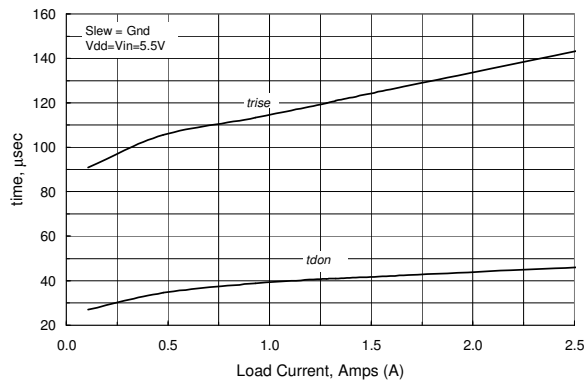

Figure 11. Switching Time vs. Load Current (SLEW = GROUND)

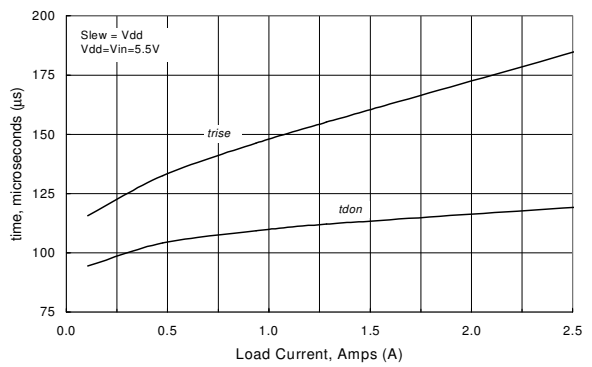
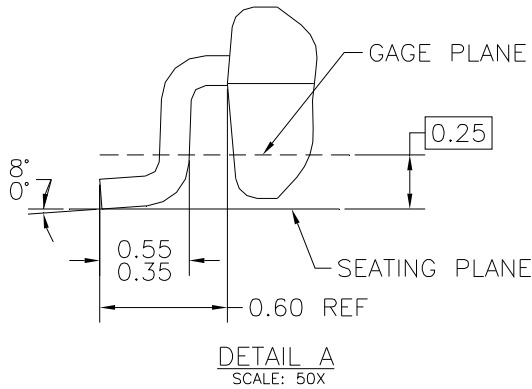
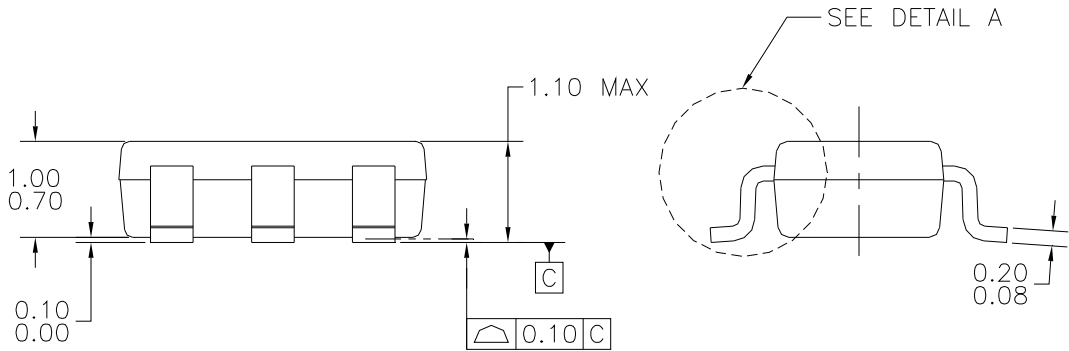
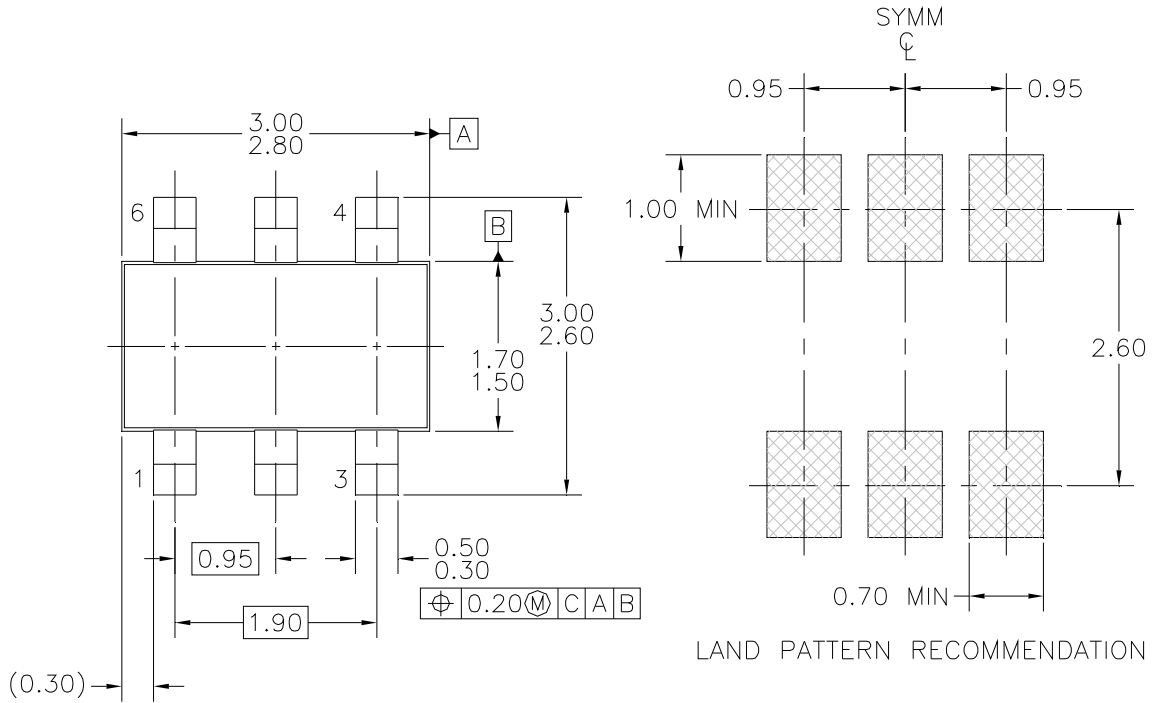

Figure 12. Switching Time vs. Load Current (SLEW = V_{DD})

Dimensional Outline and Pad Layout



NOTES: UNLESS OTHERWISE SPECIFIED



- A) THIS PACKAGE CONFORMS TO JEDEC MO-193. VAR. AA, ISSUE C, DATED JANUARY 2000.
- B) ALL DIMENSIONS ARE IN MILLIMETERS.

MA06AREVD



TRADEMARKS

The following includes registered and unregistered trademarks and service marks, owned by Fairchild Semiconductor and/or its global subsidiaries, and is not intended to be an exhaustive list of all such trademarks.

ACEx [®]	FPS [™]	PDP-SPM [™]	SupreMOS [™]
Build it Now [™]	FRFET [®]	Power220 [®]	SyncFET [™]
CorePLUS [™]	Global Power Resource SM	POWEREDGE [®]	SYSTEM [®]
CROSSVOLT [™]	Green FPS [™]	Power-SPM [™]	GENERAL [®]
CTL [™]	Green FPS [™] e-Series [™]	PowerTrench [®]	The Power Franchise [®]
Current Transfer Logic [™]	GTO [™]	Programmable Active Droop [™]	power [®]
EcoSPARK [®]	i-Lo [™]	QFET [®]	the
EZSWITCH [™] *	IntelliMAX [™]	QS [™]	franchise
	ISOPLANAR [™]	QT Optoelectronics [™]	TinyBoost [™]
	MegaBuck [™]	Quiet Series [™]	TinyBuck [™]
Fairchild [®]	MICROCOUPLER [™]	RapidConfigure [™]	TinyLogic [®]
Fairchild Semiconductor [®]	MicroFET [™]	SMART START [™]	TINYOPTO [™]
FACT Quiet Series [™]	MicroPak [™]	SPM [®]	TinyPower [™]
FACT [®]	MillerDrive [™]	STEALTH [™]	TinyPWM [™]
FAST [®]	Motion-SPM [™]	SuperFET [™]	TinyWire [™]
FastvCore [™]	OPTOLOGIC [®]	SuperSOT [™] -3	μSerDes [™]
FlashWriter [®] *	OPTOPLANAR [®]	SuperSOT [™] -6	UHC [®]
		SuperSOT [™] -8	Ultra FRFET [™]
			UniFET [™]
			VCX [™]

* EZSWITCH[™] and FlashWriter[®] are trademarks of System General Corporation, used under license by Fairchild Semiconductor.

DISCLAIMER

FAIRCHILD SEMICONDUCTOR RESERVES THE RIGHT TO MAKE CHANGES WITHOUT FURTHER NOTICE TO ANY PRODUCTS HEREIN TO IMPROVE RELIABILITY, FUNCTION, OR DESIGN. FAIRCHILD DOES NOT ASSUME ANY LIABILITY ARISING OUT OF THE APPLICATION OR USE OF ANY PRODUCT OR CIRCUIT DESCRIBED HEREIN; NEITHER DOES IT CONVEY ANY LICENSE UNDER ITS PATENT RIGHTS, NOR THE RIGHTS OF OTHERS. THESE SPECIFICATIONS DO NOT EXPAND THE TERMS OF FAIRCHILD'S WORLDWIDE TERMS AND CONDITIONS, SPECIFICALLY THE WARRANTY THEREIN, WHICH COVERS THESE PRODUCTS.

LIFE SUPPORT POLICY

FAIRCHILD'S PRODUCTS ARE NOT AUTHORIZED FOR USE AS CRITICAL COMPONENTS IN LIFE SUPPORT DEVICES OR SYSTEMS WITHOUT THE EXPRESS WRITTEN APPROVAL OF FAIRCHILD SEMICONDUCTOR CORPORATION.

As used herein:

1. Life support devices or systems are devices or systems which, (a) are intended for surgical implant into the body or (b) support or sustain life, and (c) whose failure to perform when properly used in accordance with instructions for use provided in the labeling, can be reasonably expected to result in a significant injury of the user.
2. A critical component in any component of a life support, device, or system whose failure to perform can be reasonably expected to cause the failure of the life support device or system, or to affect its safety or effectiveness.

PRODUCT STATUS DEFINITIONS

Definition of Terms

Datasheet Identification	Product Status	Definition
Advance Information	Formative or In Design	This datasheet contains the design specifications for product development. Specifications may change in any manner without notice.
Preliminary	First Production	This datasheet contains preliminary data; supplementary data will be published at a later date. Fairchild Semiconductor reserves the right to make changes at any time without notice to improve design.
No Identification Needed	Full Production	This datasheet contains final specifications. Fairchild Semiconductor reserves the right to make changes at any time without notice to improve the design.
Obsolete	Not In Production	This datasheet contains specifications on a product that has been discontinued by Fairchild Semiconductor. The datasheet is printed for reference information only.

Rev. I33